

Exit Switches



410 & 420 SERIES

The illuminated switch button is two inches square for easy activation and is visually conspicuous. The high impact resistant material stands up to abuse.

The "PUSH TO EXIT" sign complies with NFPA requirements. The 422A is designed for access and egress applications for the disabled.

MODELS

1 GANG	Narrow
422	412N
423	413N
423P	413PN
424	414N
425	415N
422A	
423A	

SPECIFICATIONS

Contact	SPDT/DPDT, 5 Amp @ 30VDC Resistive
Timer	DPDT 2 Amp @ 12/24VDC
Wire Leads	6", 20 Gauge
1 Gang	2 7/8" x 4 1/2" x 20 Ga.
Narrow	1 3/4" x 4 1/2" x 20 Ga.

HOW TO ORDER

1 Gang: 2" Button, Green Illuminated Button
Narrow: 1 3/4"x1" Button, Green Illuminated Button

1| SPECIFY MODEL

1 Gang	Narrow	Contact	Sign
422	412N	Momentary SPDT	PUSH TO EXIT
423	413N	Integrated electronic timer, adj. 1-60 sec, 12/24VDC, DPDT 2Amp contact	PUSH TO EXIT
423PU	413PN	Integrated pneumatic timer, adj. 1-180 sec. 12/24VDC, SPDT 3Amp contact	PUSH TO EXIT non-illuminated
424	414N	Momentary DPDT	PUSH TO EXIT
425	415N	AA (On/Off) DPDT	NONE



2| SPECIFY FINISHES

U Stainless Steel - Standard	D 606 Dull Brass
C 605 Bright Brass	P 625 Bright Chrome
H 613 Oil Rubbed Bronze	

3| SPECIFY OPTIONS

L1G 1 Green LED	LT Tri-color LED - Red, Green, Amber
L1R 1 Red LED	R Red Button in lieu of green
L2 1 Red,1 Green LED	

2" Button - Blue Illuminated button only

422A	Momentary SPDT	
423A	Integrated electronic timer, adj. 1-60 sec, 12/24VDC, DPDT 2Amp contact	



430 SERIES MUSHROOM EXIT SWITCH

The **SDC 430 Heavy Duty Industrial Series** incorporates a 1-1/2" round mushroom button with heavy duty contacts. The assembly is capable of withstanding high impact and is ideal for heavy duty high frequency use.



440 HEAVY DUTY SERIES

The conspicuous **440 Heavy Duty Industrial Series Switch** assemblies incorporates a 2 5/8" inch diameter mushroom button and heavy duty weather resistant contacts. The large 2 gang mushroom assembly includes a heavy duty steel bezel around the button to guard against abuse. When utilized as an Exit or REX switch, the assembly is easy to activate and stands out for persons without prior knowledge of egress operation.

In addition to egress applications, the large assembly is ideal as an easy to activate Emergency/Panic Alarm switch.

HOW TO ORDER

1| SPECIFY MODEL

1.5" Mushroom, Green Button Standard

1 Gang	Narrow	2 Gang	Contact	Sign
431C	431CN		AA (On/Off) NC SPST	None
431O	431ON		AA (On/Off) NO SPST	None
432C	432CN		Momentary NC SPST	EXIT
432O	432ON		Momentary NO SPST	EXIT
		433	Momentary with Timer Module, Adj. 1-60 seconds 12/24V AC/DC, SPDT 2A contact	EXIT
434	434N		Momentary DPST	EXIT
435	435N		AA (On/Off) DPST	None

2| SPECIFY FINISHES

- U** Stainless Steel - Standard
- C** 605 Bright Brass
- H** 613 Oil Rubbed Bronze
- D** 606 Dull Brass
- P** 625 Bright Chrome

3| SPECIFY OPTIONS

- L1G** 1 Green LED
- L1R** 1 Red LED
- L2** 1 Red, 1 Green LED
- LT** Tri-color LED - Red, Green, Amber
- R** Red Button in lieu of green

HOW TO ORDER

Latching Function with Key

The SDC **432KLDUR** and **432KUR** latches when depressed and must be reset with the built-in-key. Applications include alarm, panic alarm and emergency door release where systems are restored by authorized personnel only.

1.5" Mushroom, Red Button Standard, Dull Stainless Steel

1 Gang	Narrow	Contact	Sign
432KLDUR		Latching/ key reset DPST	LOCKDOWN
432KUR	432KNUR	Latching/ key reset DPST	none

SPECIFICATIONS

Contact	6 Amp @ 30VDC
Wire Connection	Screw Terminals
1 Gang	2 7/8" x 4 1/2" x 20 Ga.
Narrow	1 3/4" x 4 1/2" x 20 Ga.
2 Gang	4 1/2" x 4 1/2" x 20 Ga.



HOW TO ORDER

1| SPECIFY MODEL

2-5/8" Mushroom, Red Button Standard, Specify G For Optional Green button

1 Gang	2 Gang	Contact	Sign
	441	AA (On/Off) DPST	None
	442	Momentary DPST	EXIT
	443	Momentary with Timer Module, Adj. 1-60 seconds 12/24V AC/DC, SPDT 2A contact	EXIT
446	444	Momentary 2-DPST	EXIT
		Momentary DPST	EXIT

2| SPECIFY FINISHES

- U** Stainless Steel - Standard
- C** 605 Bright Brass
- H** 613 Oil Rubbed Bronze
- D** 606 Dull Brass
- P** 625 Bright Chrome

3| SPECIFY OPTIONS

- L1G** 1 Green LED
- L1R** 1 Red LED
- L2** 1 Red, 1 Green LED
- LT** Tri-color LED - Red, Green, Amber
- E** Add Exit sign To AA Function Switch
- G** Green button in lieu of Red

Example: Model	Finish	Option
432O	U	L2
446	U	L2

SPECIFICATIONS

Button	Mushroom, 2 5/8"
Contact	6 Amp @ 30VDC
Wire Connections	Screw Terminals
1 Gang	2 7/8" x 4 1/2" x 20 Ga.
2 Gang	4 1/2" x 4 1/2" x 20 Ga.



450 VANDAL RESISTANT SERIES

The **SDC 450 Series** incorporates a 1/4" thick aluminum faceplate and an all stainless steel button. The assembly will resist the impact of a hammer blow. In addition, security spanner mounting screws are concealed by tamper resistant aluminum plugs to inhibit tampering.

Pneumatic Time Delay

The 453PTD includes a 1 to 180 second pneumatic timer for delayed re-locking. Where preferred, the 10TD Electronic Mini Timer may be specified for use with the standard 452 model (see page 4).

MODELS

- 451V** 1 Gang Exit Switch AA (On/Off) SPDT
- 451NV** Narrow Exit Switch AA (On/Off) SPDT
- 452V** 1 Gang Exit Switch Momentary SPDT
- 452NV** Narrow Exit Switch Momentary SPDT
- 453PV** 1 Gang Exit Switch Integrated Pneumatic Timer
Adj. 1-180 sec. DPST contact
- 453PNV** Narrow Exit Switch Integrated Pneumatic Timer
Adj. 1-180 sec. DPST contact

HOW TO ORDER

1| SPECIFY MODEL

Stainless Steel Button - 1/4" Thick Aluminum Plate - Security Screws Plated Finish Not Available

1 Gang	Narrow	Contact	Sign
451V	451NV	AA (On/Off) SPDT	None
452V	452NV	Momentary SPDT	None
453PV	453PNV	Integrated Pneumatic Timer Adj. 1-180 sec. DPST contact	None

SPECIFICATIONS

Button	Round Dull Stainless Steel button, 1/2"
Contact	6 Amp @ 30VDC
Wire Connections	451/452: 6", 20 gauge, 453: Screw terminals
1 Gang	2 7/8" x 4 1/2" x 1/4"
Narrow	1 3/4" x 4 1/2" x 1/4"

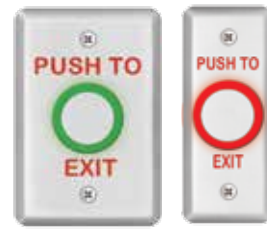

460 VANDAL RESISTANT

FEATURES

- Vandal resistant stainless steel piezoelectric button and faceplate
- No moving parts
- Billion cycle button technology
- Bi-color status indicator, Red and Green
- Integrated timer, adj. 1-30 seconds or toggle on/off

The **SDC 460 Series** is a heavy duty, vandal resistant exit switch designed for harsh indoor or outdoor environments. The stainless steel piezoelectric technology is also ideal for high traffic applications. The switch assembly design ensures superior performance in virtually any environment.

MODELS

- 463U** 1 Gang Exit Switch
- 463NU** Narrow Exit Switch

HOW TO ORDER

1| SPECIFY MODEL

1/8" Stainless Steel - Security Screws - Plated Finish Not Available

1 Gang	Narrow	Contact	Sign
463U	463NU	Integrated 1-30 Sec Timer, SPDT 3A contact	PUSH TO EXIT / EXIT

SPECIFICATIONS

Input Voltage	12/24VDC
Current	LED On: Idle-60mA, Active-120mA, LED Off: Idle-10mA, Active-60mA
Outputs	SPDT 3 Amp @ 30VDC
Relay Life Expectancy	100,000 cycles @ 3A 30VDC 200,000 cycles @ 1A 30VDC
Operating Temp	-40° F to +160° F
1 Gang	4.5" H x 2.75" W x 1.25" D
Narrow	4.5" H x 1.75" W x 1.25" D



474U 2-SPDT TOUCHLESS EXIT SWITCH

The **SDC 474U** uses IR Sensor technology, the device is active with the simple wave of a hand. Designed to control electric locks/strikes, magnetic locks, or automatic door openers. It is ideal for use in sanitary applications, such as cleanrooms, bathrooms, food processing, hospitals and labs, and features a sensing range of up to 4" (10cm). The Switch is mounted on a durable stainless steel plate, with dual LED illuminated sensors indicating the status. The quick connect screwless terminal block ensures easy installation.



CODE COMPLIANT MANUAL RELEASING SWITCH

423M and **413MN Exit Switches** used together with the MD31D PIR sensor comply with manual releasing device and sensor device requirements for Access-Controlled Egress Doors per the following codes:

- ICC International Building Code 1008.1.3.4
- IFC International Fire Code 1008.1.3.4
- NFPA 101 Life Safety Code 7.2.1.6.2
- California Fire Code

1 Gang: 2" Button, Green Illuminated Button
Narrow: 1 3/4" x 1" Button, Green Illuminated Button

 **HOW TO ORDER**

1| **SPECIFY MODEL**

474U Exit Switch

 **HOW TO ORDER**

1| **SPECIFY MODEL**

1 Gang	Narrow	Contact	Sign
423M	413MN	Integrated electronic timer, fixed 30 sec timer, 12/24VDC, DPDT 5Amp contact Resistive	PUSH TO EXIT

2| **SPECIFY FINISHES**

U Stainless Steel - Standard	D 606 Dull Brass
C 605 Bright Brass	P 625 Bright Chrome
H 613 Oil Rubbed Bronze	

3| **SPECIFY OPTIONS**

L1G 1 Green LED	LT Tri-color LED - Red, Green, Amber
L1R 1 Red LED	
L2 1 Red, 1 Green LED	R Red Button in lieu of green

 **SPECIFICATIONS**

Input	25mA (standby); 55mA (Active) @ 12/24VDC
Output	2-SPDT, 3 Amp Dry Contact
Activation Time	1 second or as long as sensor is triggered
LED Color	Standby RED; Active Green
Range	4"
Weight	3 oz.
Dimensions	4.5" x 2.75" x 1.375"

 **SPECIFICATIONS**

Contact	Momentary, DPDT 5 Amp @ 30VDC Resistive
Wire Leads	6", 20 Gauge
1 Gang	2-7/8" x 4-1/2" x 20 Ga.
Narrow	1-3/4" x 4-1/2" x 20 Ga.





EMERGENCY BREAK GLASS STATION

The **SDC 491 Emergency Door Release Break Glass Station** provides immediate unlocking of perimeter doors or interior doors that are equipped with fail-safe electric locks. The 491's built in alarm may be used as a local door annunciator.

The SDC 491 is specifically designed for emergency door release and may influence the approval of an electric locking system. This type of Emergency Door Release may be preferred over a pull station since greater commitment is required to break the glass.



EMERGENCY PULL STATION

The SDC 492 Emergency Door Release Pull Station provides immediate unlocking of perimeter doors or interior doors that are equipped with fail-safe electric locks. The 492's built in alarm may be used as a local door annunciator.

The SDC 492 is specifically designed for emergency door release and may influence the approval of an electric locking system.



MODELS

- 491** Emergency Door Release-2 Replacement Glasses
- 491-GL4** Door Release-4 Replacement Glasses
- 491-BB** Blue Back Box



MODELS

- 492** Pull station emergency door release with siren
- 492-GL4** Four replacement glass rods
- 492-BB** Blue surface mount back box



HOW TO ORDER

1| SPECIFY MODEL

- 491** Break glass emergency door release with siren 3V-28VDC, 18mA (2 replacement glass pieces included)
- 491-GL4** Four replacement glass plates
- 491-BB** Blue surface mount back box



HOW TO ORDER

1| SPECIFY MODEL

- 492** Pull station emergency door release with siren 3V-28VDC, 18mA
- 492-GL4** Four replacement glass rods
- 492-BB** Blue surface mount back box



COMMUNICATING BATHROOM SYSTEM CONTROLS

For a common single bathroom shared by two patient rooms or dormitory rooms, the **CB400A** controls provides privacy and ensures that both doors are locked only when the bathroom is occupied and unlocked when the bathroom is not occupied. The CB400B controls provide emergency access by facility staff. Both doors unlock when signalled by the fire life safety system.



MODELS

CB401A
CB401B
CB402A
CB402B



SPECIFICATIONS

Contact SPDT 5 Amp @ 30VDC
Wire Leads 6", 20 Gauge
1 Gang 2 7/8" x 4 1/2" x 20 Ga.



HOW TO ORDER

1| SPECIFY MODEL

For Communicating Bathroom Systems with EMLocks

CB401A The CB401A is located inside the bathroom. Depressing the button locks both doors for privacy. Pressing the button again unlocks both doors ensuring both doors are unlocked when unoccupied.

CB401B The CB401B Emergency door release (2 required) is located outside the bathroom above or adjacent to the door. The illuminated push switch button indicates the doors are locked. Depressing the push switch unlocks both doors.

Additional Components Required:

- **2 EMLock's:** 1581VD – 650lbs Holding Force or 1571VD – 1200lbs Holding Force
- 631RF-UR-1 Power Supply

For Communicating Bathroom Systems with Electrified Locksets

CB402A The CB402A is located inside the bathroom. Depressing the push switch locks both doors on the outside only. Doors are always unlocked on the inside for uninhibited egress. Exiting either door causes both doors to unlock.

CB402B The CB402B Emergency door release (2 required) is located outside the bathroom above or adjacent to the door. The illuminated push switch button indicates the doors are locked. Depressing the push switch unlocks both doors.

Additional Components Required:

- 2 each Electrified Locksets: Z7250 Electrified Cylindrical lock with Rex output or Z7850-R Electrified Mortise lock with REX output
- PTH-4Q Four Wire Power Transfer Hinge
- 631RF – UR-1 Power Supply
- MC-4 - 2 each optional

COMMUNICATING BATHROOM EMLOCK® SYSTEM

APPLICATIONS

Single hospital bathroom shared by two patient rooms.

SYSTEM OPERATION

Both doors must be closed to lock.

Activating CB401A (B) locks both doors.

Activating CB401A (B) again unlocks both doors.

When doors are locked, activating either CB401B (C) emergency release will unlock both doors.

Both doors will unlock automatically via signal from fire panel.

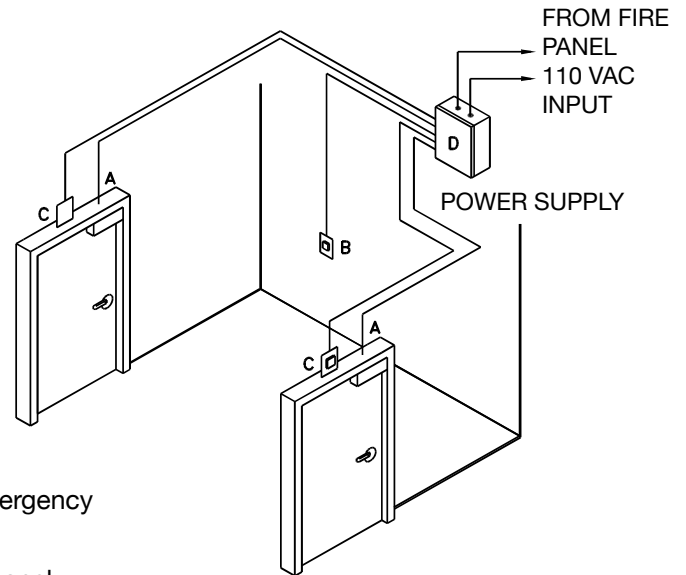

SYSTEM COMPONENTS

- (A) Fail Safe locks with door position switch. Example: **1511-DPS**
- (B) **CB401A** System activation push switch.
- (C) **CB401B** Emergency release push switch to be mounted above each door.
CB701B key switch optional.
- (D) **631RFxUR1** Power Supply with Fire Panel Tie-In.

COMMUNICATING BATHROOM SELECTRIC® OR ELECTRA® SYSTEM

APPLICATION

Single hospital bathroom shared by two patient rooms.

SYSTEM OPERATION

Both doors must be closed to lock.

Activating CB402A (B) locks both doors.

When doors are locked, turning either inside door lever unlocks both doors.

When doors are locked, activating either CB402B (C) emergency release will unlock both doors.

Both doors will unlock automatically via signal from fire panel.

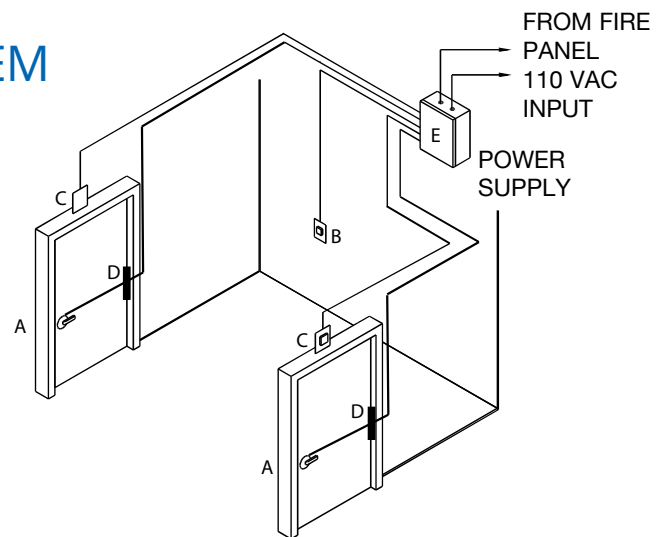

SYSTEM COMPONENTS

- (A) Fail Safe locks with door position switch or REX. Examples: **7850-RD** or **7250**
- (B) **CB402A** System activation push switch.
- (C) **CB402B** Emergency release push switch to be mounted above each door.
CB702B key switch optional.
- (D) **PTH-4-DPS**
- (E) **631RFxUR1** Power Supply with Fire Panel Tie-In.

MINI TIMER MODULE



The **Electronic Mini Timer** delays relocking of access controlled door to provide persons ample time needed to complete door entry or egress. The Mini Timer is compatible with all SDC momentary key and exit switches equipped with a momentary normally open contact. The module assembly fits inside a two gang key or exit switch assembly or may be installed separately in a narrow frame or remote junction box.

MODELS

10TD Mini Timer Module, Adjustable 1 - 60 seconds

SPECIFICATIONS

Input	12/24 VDC / VAC @ 50 mA
Trigger Input	N.O. Dry
Contact	SPDT Dry, 2 Amps @ 30VDC
Wire Leads	6", 20 Gauge
Size	3/4" x 1-1/2" x 2-1/4"

PIR EGRESS SENSOR



The **MD31D PIR Request-to-Exit Sensor** unlocks doors automatically when persons approaching door are detected. The MD31D complies with national fire and building code requirements for Access Controlled Egress Doors listed above. Code compliant failsafe mode releases locks when power to PIR sensor is interrupted.

MODELS

MD-31DW White PIR Egress Sensor
MD-31DB Black PIR Egress Sensor

SPECIFICATIONS

Input	12 or 24 VAC/DC @ 26mA max
Contact	2 SPDT Dry, 2 Amp @ 30VDC
Operating Temp	-20° F to 120° F
Dimensions	1.5" H x 6.25" W x 1.5" D



UL listed 294
Access Control System Units

