



Visit website for
available languages of
this document.

EAGLE & EAGLE HM

Unidirectional activation sensor for automatic,
pedestrian doors and high-mount doors

DESCRIPTION

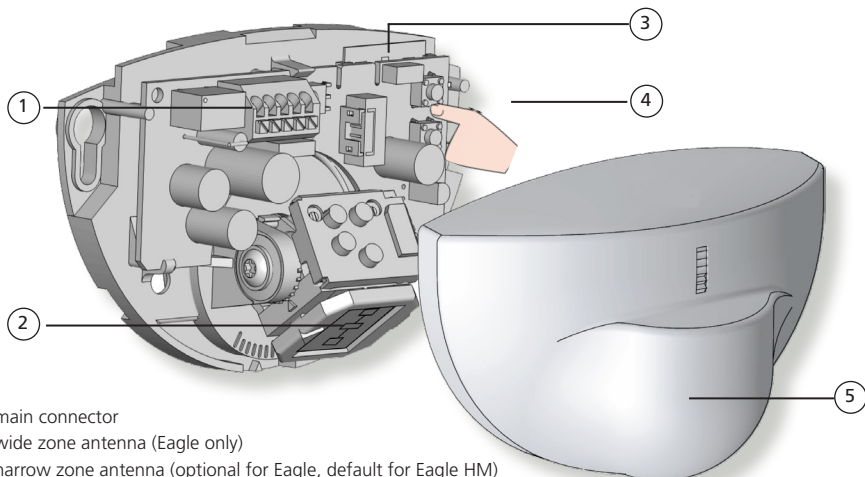

1. main connector
2. wide zone antenna (Eagle only)
3. narrow zone antenna (optional for Eagle, default for Eagle HM)
4. push buttons
5. cover

The image shown here is a standard Eagle.

Antennae differ between the standard and high-mount versions of the Eagle.

TECHNICAL SPECIFICATIONS

Technology:	microwave and microprocessor
Transmitter frequency:	24.150 GHz
Transmitter radiated power:	< 20 dBm EIRP
Transmitter power density:	< 5 mW/cm ²
Detection mode:	motion
Min. detection speed:	2 in/s
Supply voltage:	12 – 24 VAC ±10%; 12 – 24 VDC +30% / -10%
Mains frequency:	50 – 60 Hz
Max power consumption:	< 2 W
Output:	relay (free of potential changeover contact)
max. contact voltage:	42V AC/DC
max. contact current:	1A (resistive)
max. switching power:	30W (DC) / 60VA (AC)
Mounting height:	Eagle: 6' – 13' Eagle HM: 10' – 16'6"
Degree of protection:	IP54
Temperature range:	-4 – 131 °F
Dimensions:	4.7" (L) × 3.1" (H) × 2.0" (W)
Tilt angles:	0 – 90° vertical; -30 – 30° lateral
Material:	ABS
Weight:	7.6 oz
Cable length:	Eagle: 8' Eagle HM: 30'
Norm conformity:	R&TTE 1999/5/EC, LVD 2006/95/EC, RoHS 2 2011/65/EU

Specifications are subject to change without prior notice.

All values measured in specific conditions.

INSTALLATION TIPS

- Do not touch electrical parts.
- Avoid vibrations.
- Do not cover the sensor.
- Avoid proximity to neon lamps or moving objects.
- The sensor may be mounted horizontally or vertically (e.g. on a ceiling or on a wall, respectively).
 - ◊ If mounting horizontally, the sensor must be mounted in front of the door.
 - ◊ If mounting vertically, the sensor must be mounted above the door.

How to Open the Sensor:

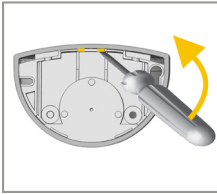

BEFORE MOUNTING

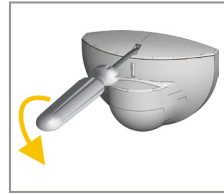

AFTER MOUNTING

MOUNTING & WIRING

If using **EAGLE SPACER** or **EAGLE SPACER V**, please refer to **User's Guide 75.5981** before beginning.

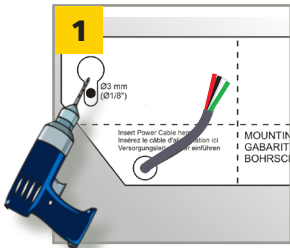

Apply the mounting template.
Drill 1 hole for the cable and pull it through.
Drill 2 holes for the screws.

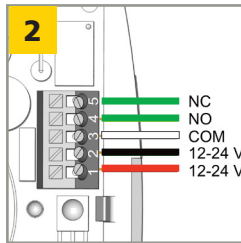

Connect the wires accordingly:
1: RED - POWER SUPPLY +
2: BLACK - POWER SUPPLY -
3: WHITE - COM
4: GREEN - NO **OR** 5: GREEN - NC

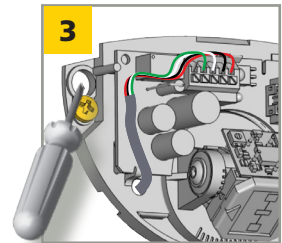

Position the cable as indicated.
Mount the sensor firmly.

MECHANICAL ADJUSTMENTS

4 **Standard EAGLE only:** Choose the appropriate antenna (narrow or wide) for the correct detection zone width.

Narrow: 6' 6" x 8'

Wide: 13' x 6' 6"

EAGLE HM only offers narrow antenna.

See diagram below for how to change antennas.

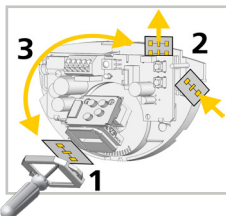

WIDE

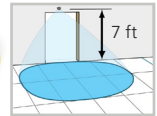

NARROW

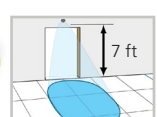
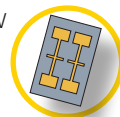

MECHANICAL ADJUSTMENTS (cont.)

5 If desired, adjust the antenna angle (laterally and/or vertically) to position the detection field.

When mounting at the maximum height, BEA recommends a 15° tilt angle.

Observe antenna type (narrow or wide) in the illustrations below.

LATERAL ADJUSTMENT

VERTICAL ADJUSTMENT

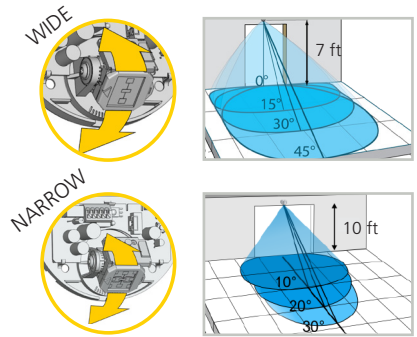
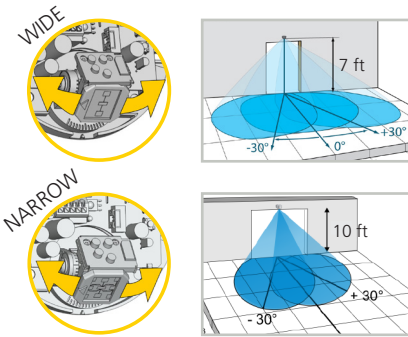

SETTINGS (by remote control or push-buttons)

6 Program the sensor for the desired application.

When mounting at the maximum height, BEA recommends the following:

Immunity = low
Zone Size = XXL



			0	1	2	3	4	5	6	7	8	9		
ZONE SIZE			XXS	XS	S	>	>	>	>	L	XL	XXL	EAGLE def. = 8 EAGLEHM def. = 7	
IMMUNITY FILTER			low	normal	high	>	>	>	L	XL	highest			
DETECTION MODE			bi	uni	uni MTF	uni AWAY	MTF & AWAY	bi = two-way detection uni = one-way detection towards sensor uni MTF = one-way detection with motion tracking feature uni AWAY = one-way detection away from sensor						
OUTPUT CONFIGURATION			A	P	A = active output (NO-contact), relay energizes upon detection P = passive output (NC-contact), relay de-energizes upon detection									
HOLD-OPEN TIME			0.5 s	1 s	2 s	3 s	4 s	5 s	6 s	7 s	8 s	9 s		
MOUNTING HEIGHT			< 10 ft	> 10 ft	Standard Eagle default = < 10 ft High-mount Eagle default = > 10 ft									
DOOR CONTROL			auto	open	closed	open = the sensor detects constantly. The LED is ON. closed = the sensor is in standby and does not detect. The LED is OFF.								

FACTORY VALUES

RESETTING TO FACTORY VALUES

USING REMOTE CONTROL:

USING PUSH-BUTTONS: 2 sec +

ACCESS CODE

The access code (1 to 4 digits) is recommended to set sensors installed close to each other.









SAVING AN ACCESS CODE:

DELETING AN ACCESS CODE:

Once you have saved an access code, you always need to enter this code to unlock the sensor.

If you forget the access code, **cycle the power**. For the first minute, you can access the sensor without an access code.

TROUBLESHOOTING

	The door remains closed. LED is off.	Sensor power is off.	Check wiring and power supply.
	Door does not react as expected	Door control setting (F2) is set to 3 (closed).	Change door control setting (F2) to 1 (automatic).
	Door opens and closes constantly	Improper output configuration on sensor.	Change the output configuration setting on each sensor connected to the door operator.
	Door opens for no discernable reason	Sensor is disturbed by door motion or vibrations from door motion.	Ensure sensor is fixed properly. Ensure detection mode is unidirectional. Increase antenna angle. Increase immunity filter. Reduce zone size.
		It rains and the sensor detects the motion of the rain drops.	Ensure detection mode is unidirectional. Increase immunity filter. Install rain accessory.
		In highly reflective environments, the sensor detects objects outside of its detection zone.	Change the antenna angle. Reduce zone size. Increase immunity filter.
		In airlock vestibules, the sensor detects the movement of the opposite door.	Change the antenna angle. Change antenna. Increase immunity filter.
	LED flashes quickly after unlocking	Sensor needs access code to unlock.	Enter correct access code. If you forgot the code, cycle the power to access the sensor without access code. Change or delete the access code.
	Sensor does not respond to the remote control	Batteries in the remote control are weak or installed improperly. Remote control not pointed correctly.	Check batteries and change if necessary. Point remote control at sensor.

BEA, INC. INSTALLATION/SERVICE COMPLIANCE EXPECTATIONS

BEA, Inc., the sensor manufacturer, cannot be held responsible for incorrect installations or inappropriate adjustments of the sensor/device; therefore, BEA, Inc. does not guarantee any use of the sensor outside of its intended purpose.

BEA, Inc. strongly recommends that installation and service technicians be AAADM-certified for pedestrian doors, IDA-certified for doors/gates, and factory-trained for the type of door/gate system.

Installers and service personnel are responsible for executing a risk assessment following each installation/service performed, ensuring that the sensor system installation is compliant with local, national, and international regulations, codes, and standards.

Once installation or service work is complete, a safety inspection of the door/gate shall be performed per the door/gate manufacturer recommendations and/or per AAADM/ANSI/DASMA guidelines (where applicable) for best industry practices. Safety inspections must be performed during each service call – examples of these safety inspections can be found on an AAADM safety information label (e.g. ANSI/DASMA 102, ANSI/DASMA 107).

Verify that all appropriate industry signage and warning labels are in place.



Tech Support: 1-800-407-4545 | Customer Service: 1-800-523-2462
General Tech Questions: Tech_Services@beainc.com | Tech Docs: www.BEAinc.com

